

20.73.1301.00

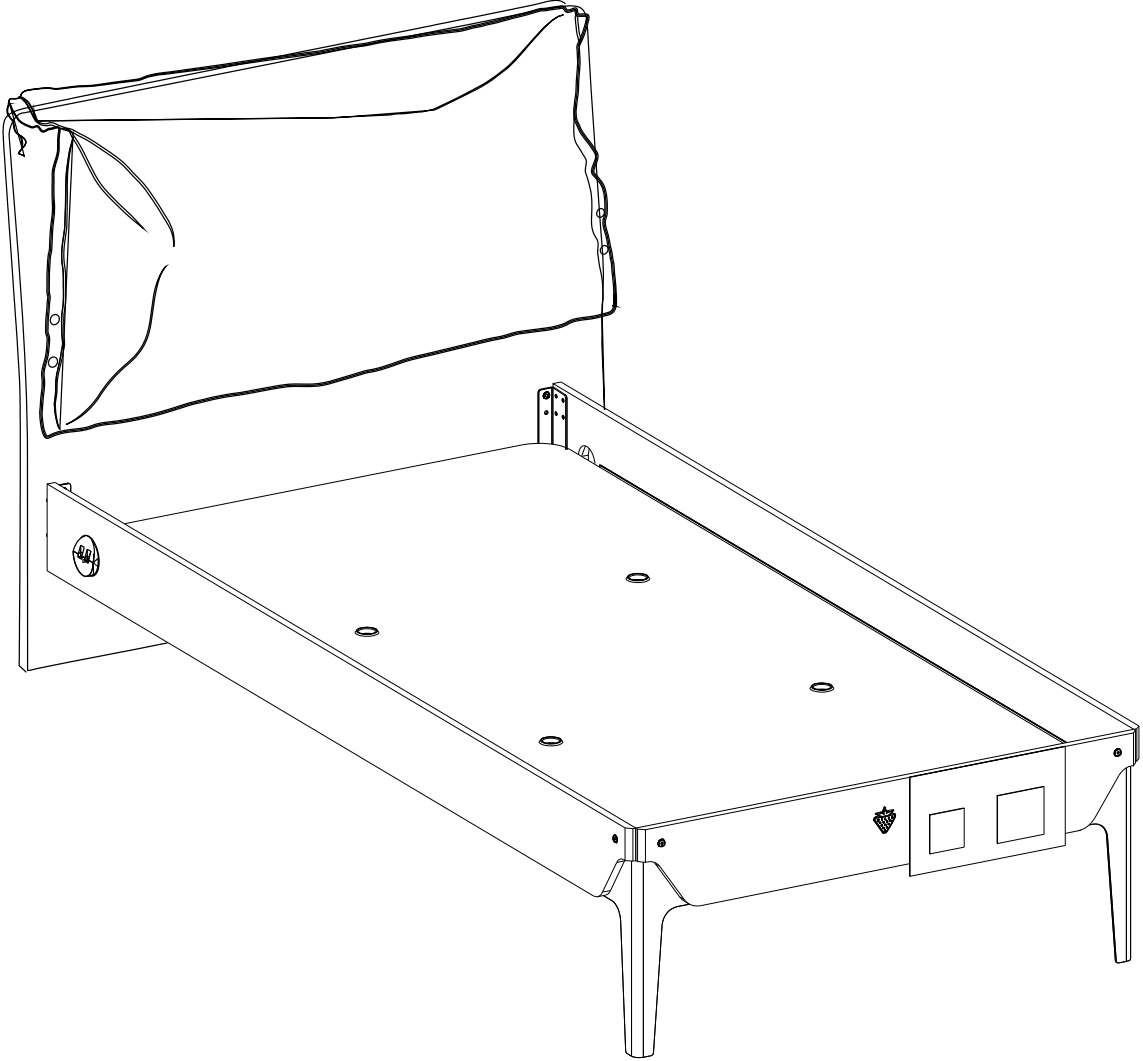

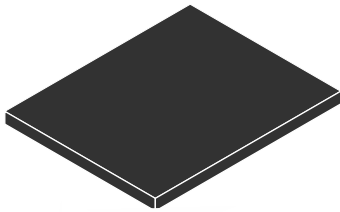

3 / 1
21.20.1019.00 x 1

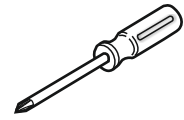
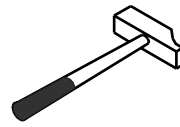
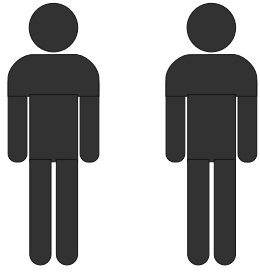
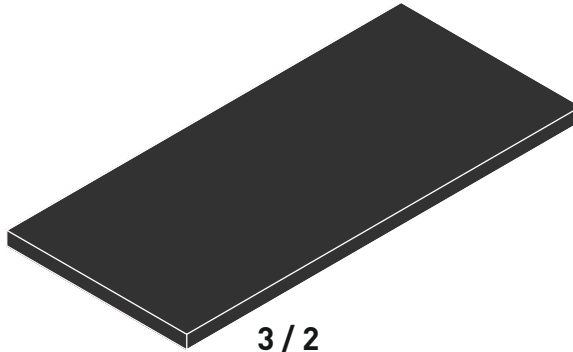

3 / 2

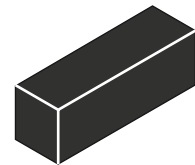

3 / 3

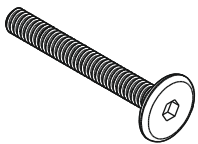

13.03.01.033 x 8

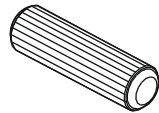

13.01.01.111 x 4



13.02.01.017 x 25

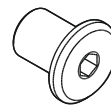

13.07.01.093 x 4

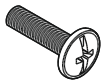

13.03.01.007 x 2



13.03.01.021 x 24

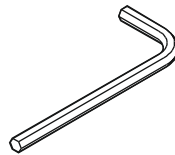

13.07.01.016 x 1

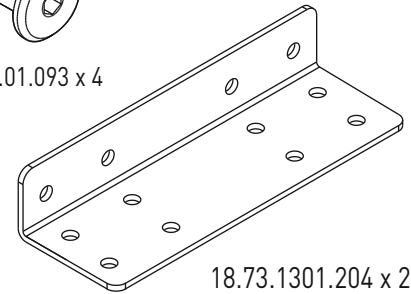

18.73.1301.204 x 2

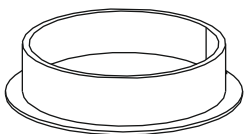

13.01.01.758 x 1

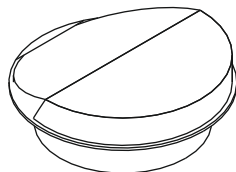

13.15.01.162 x 1

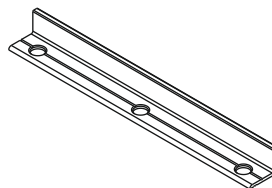

18.73.1301.203 x 1

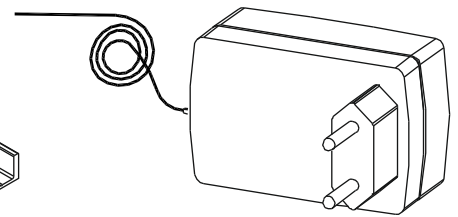

13.15.01.093 x 1

3 / 1

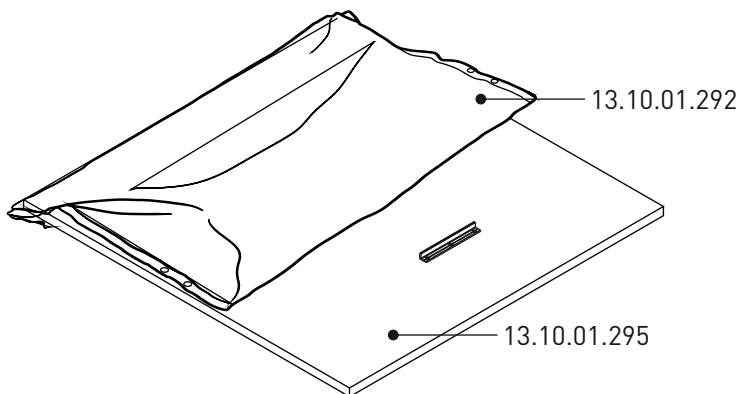

21.20.1019.00 x 1

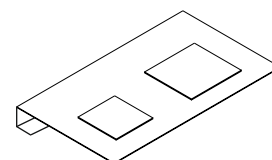

13.10.01.277 x 1

3/2

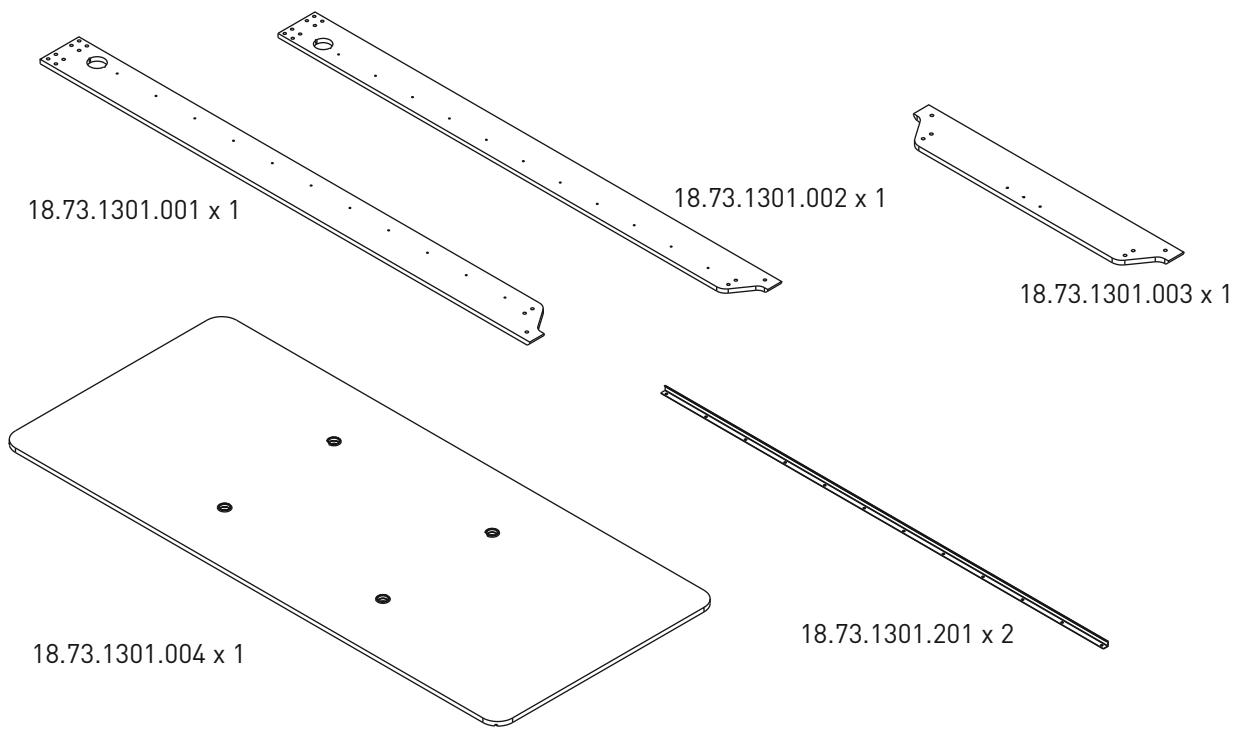

3/3

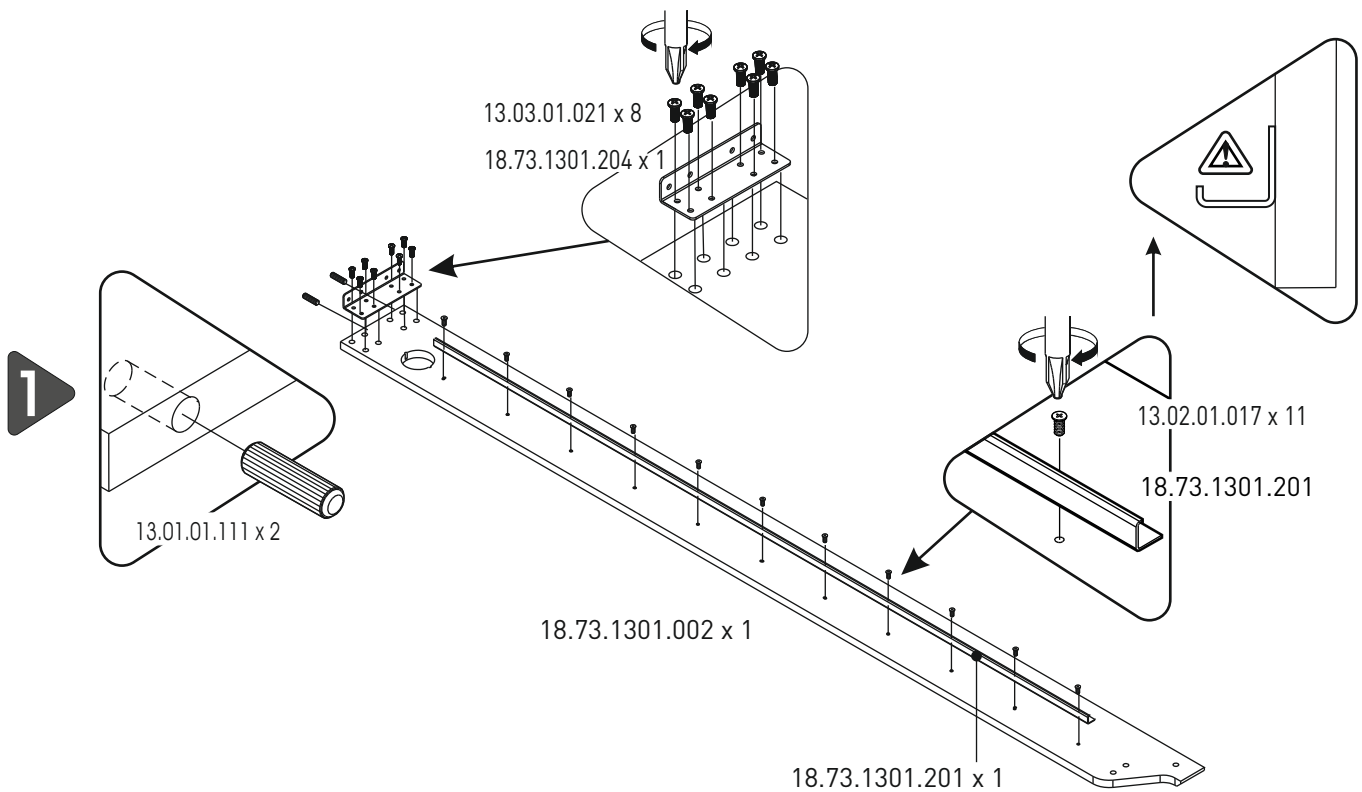
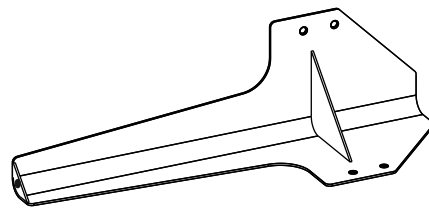

2

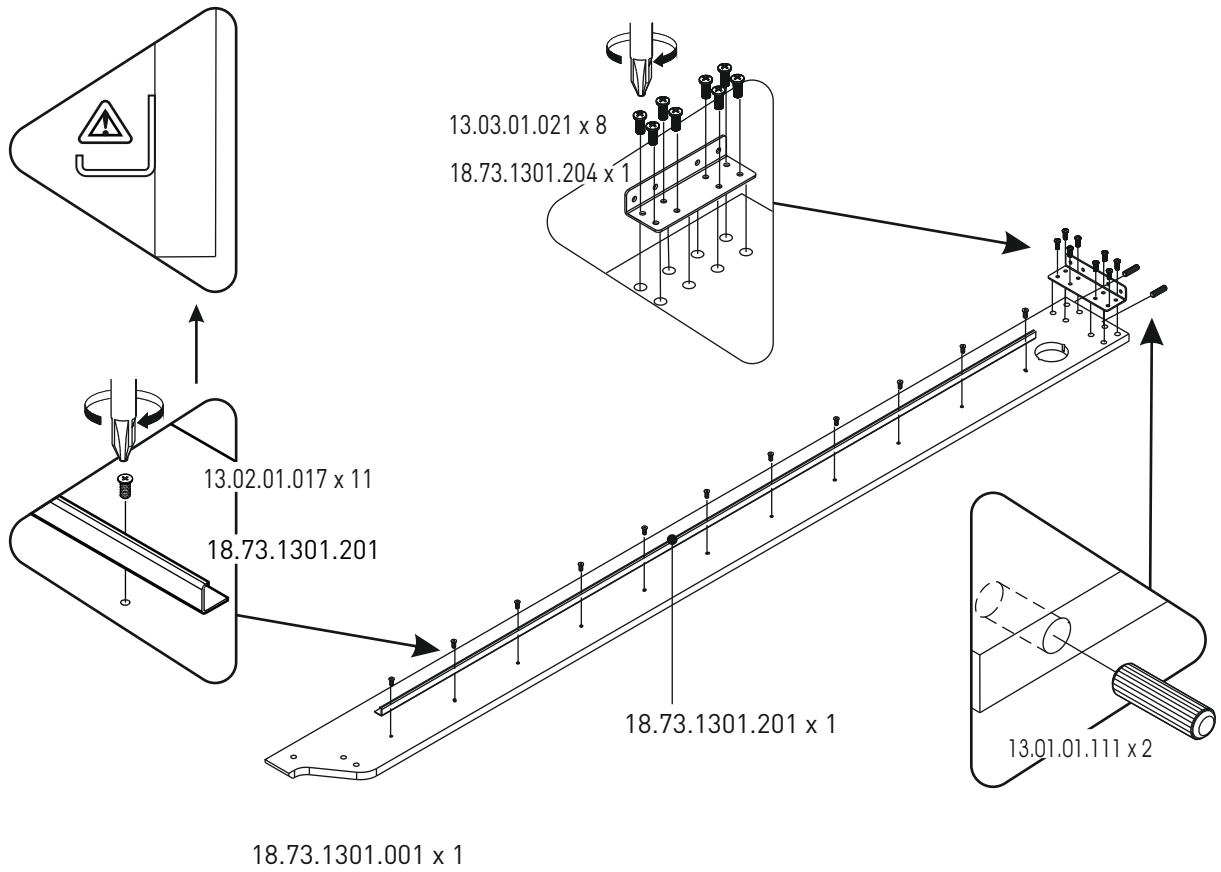

3

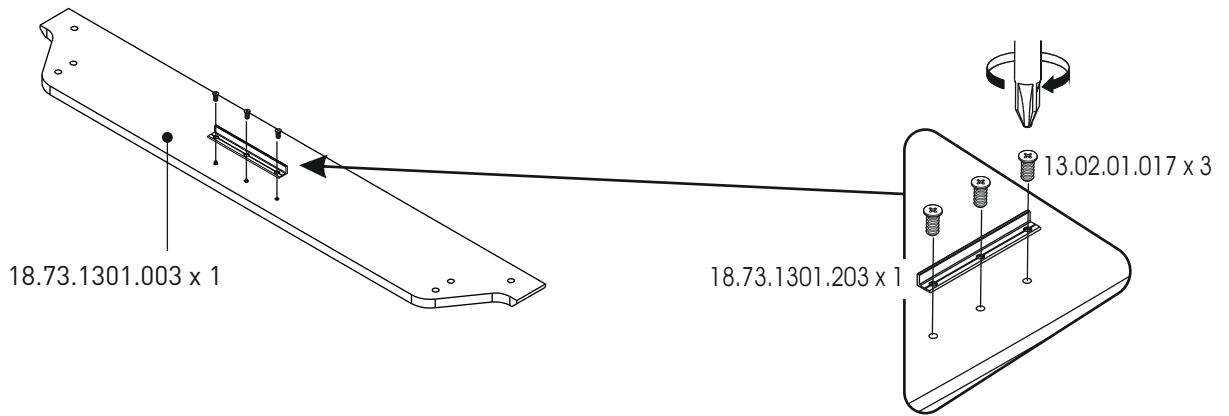

4

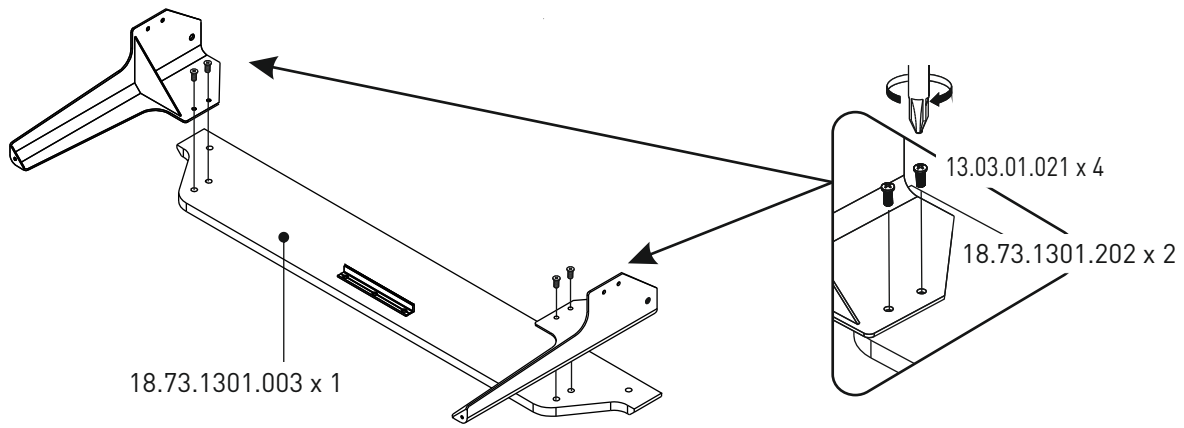

5

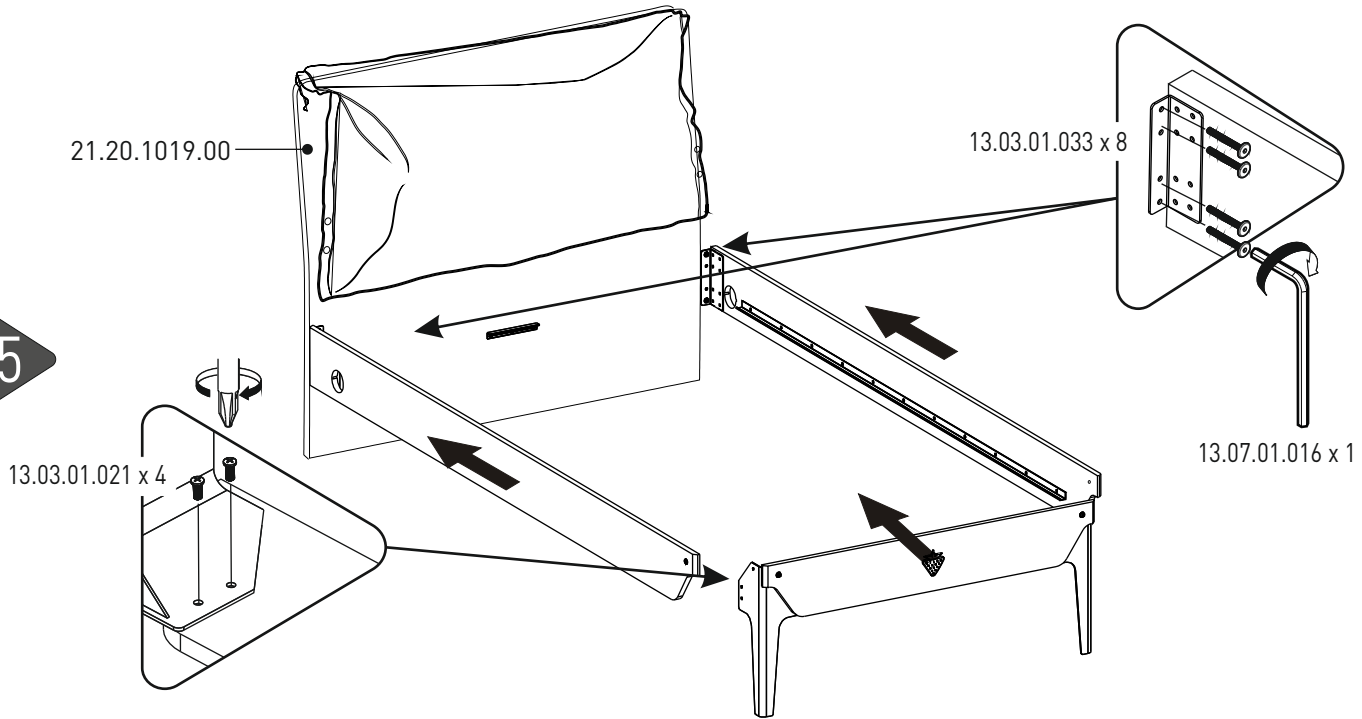

6

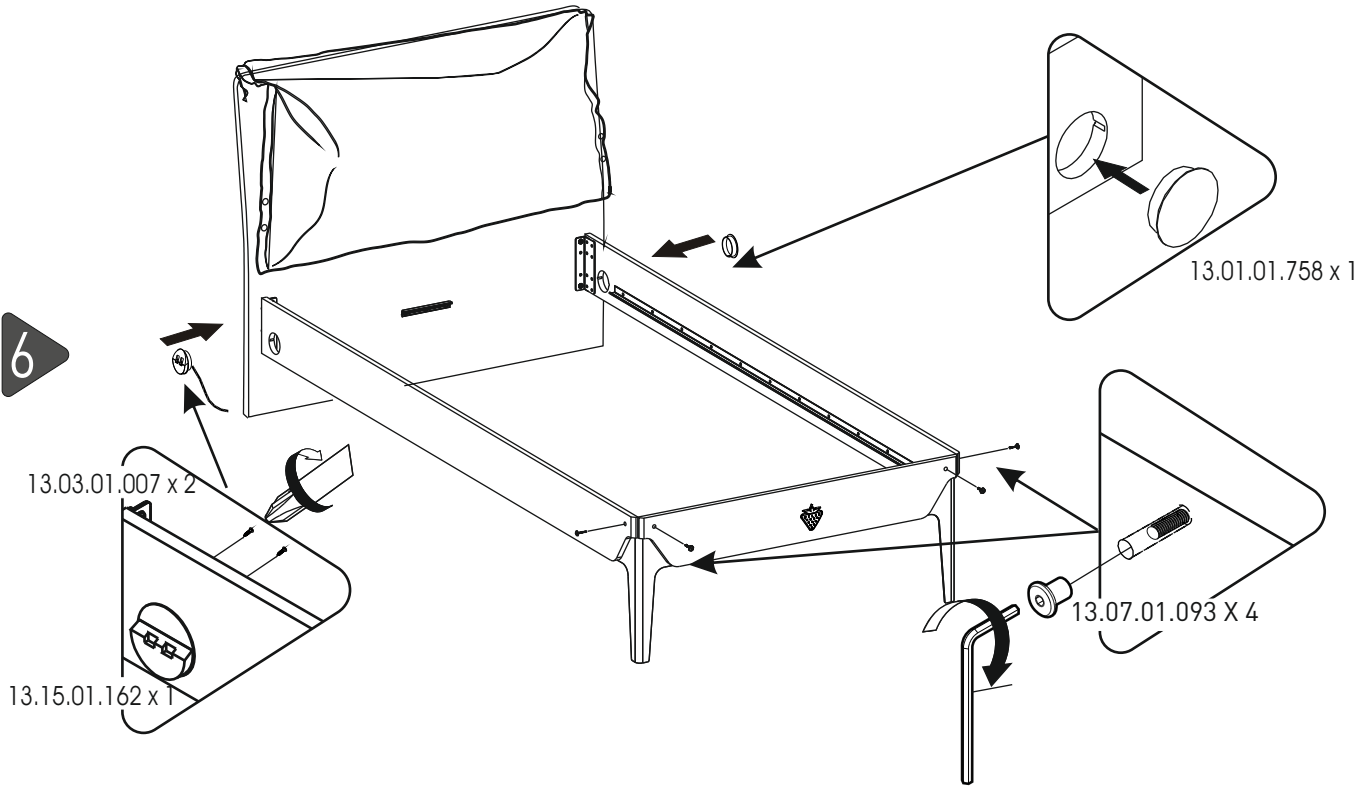

7

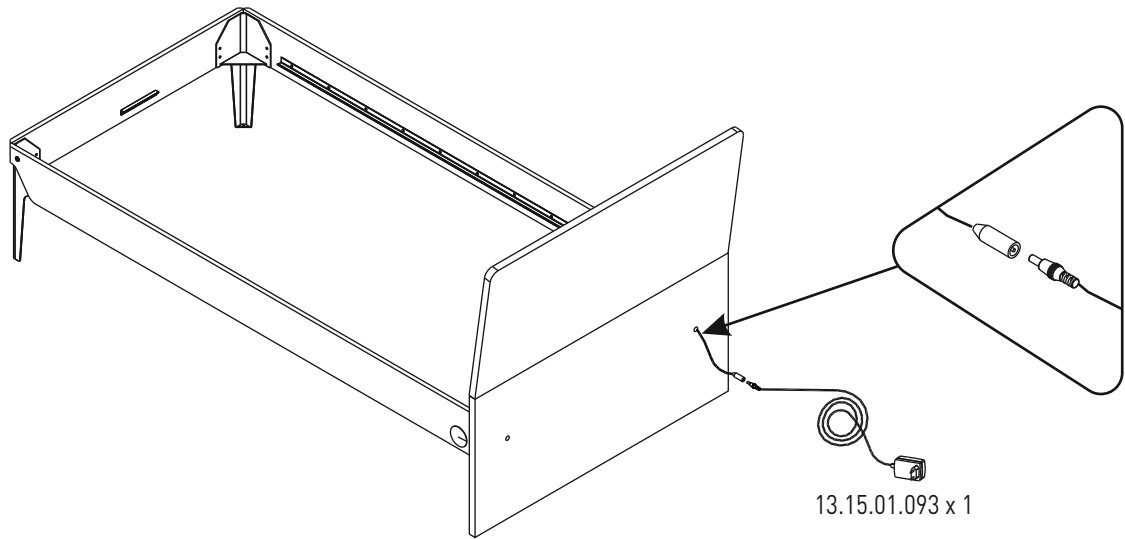

8

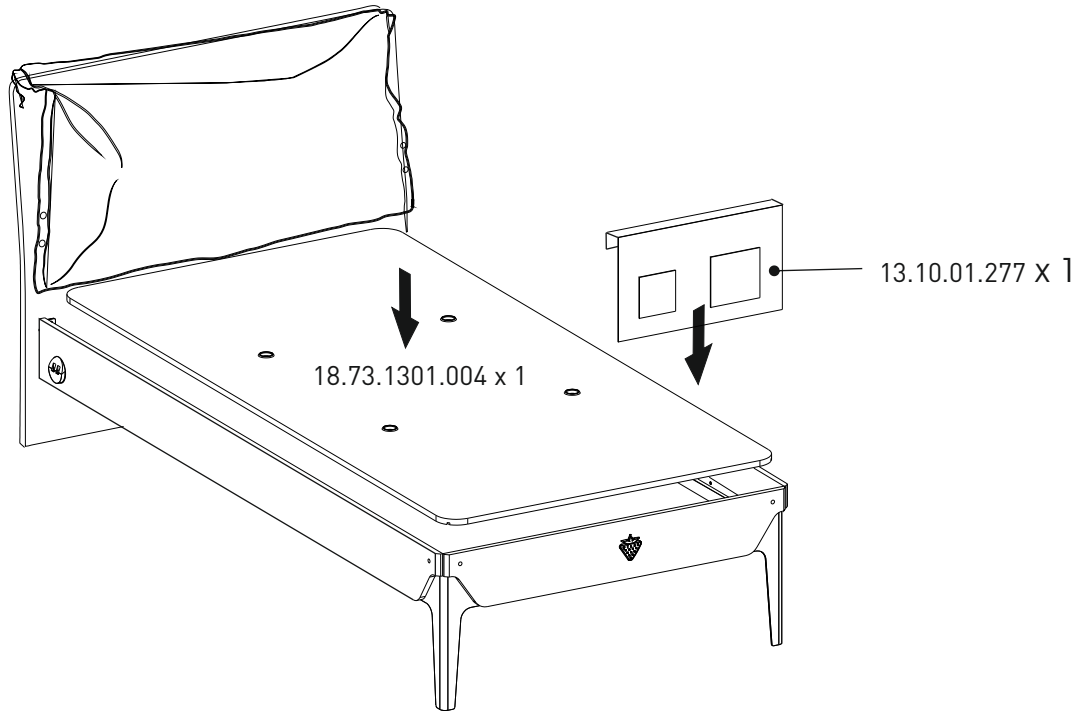

9

