

20.77.1307.00

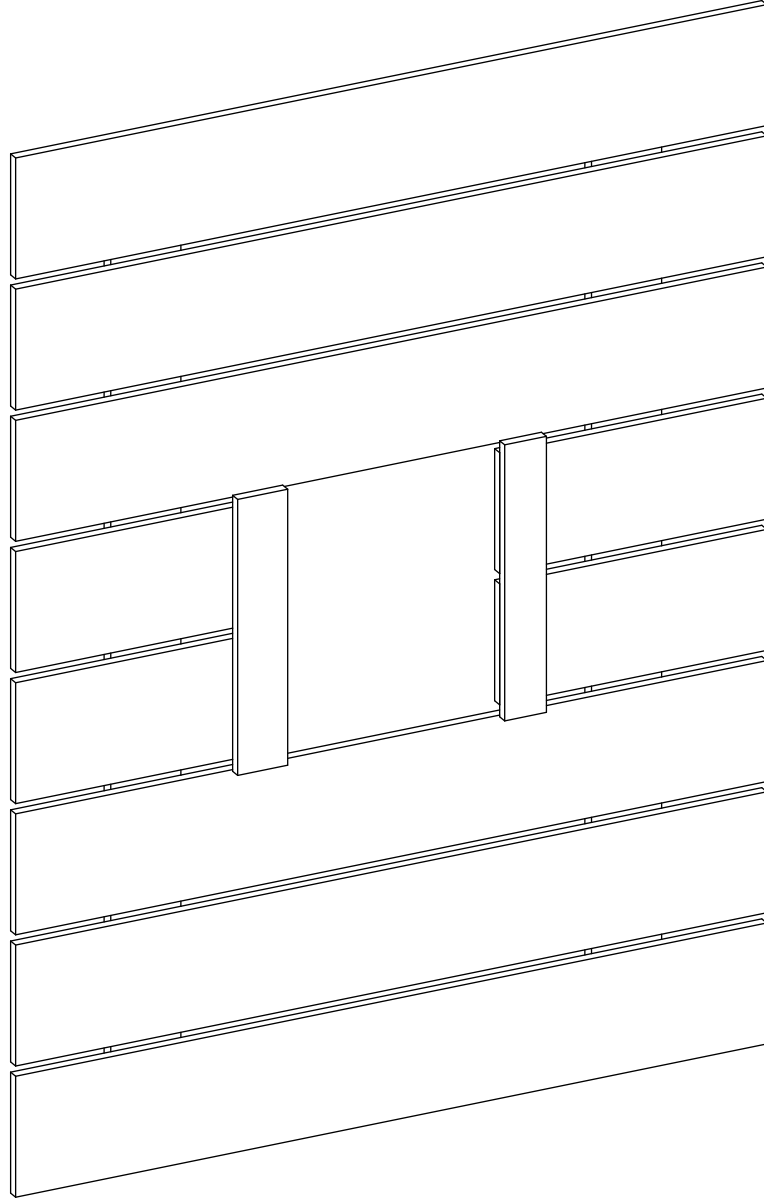

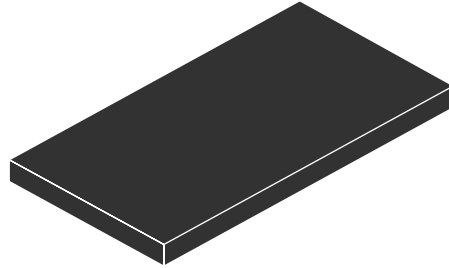

1 / 1

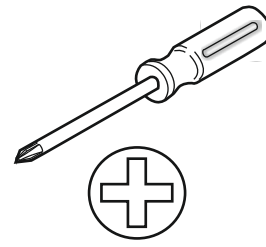
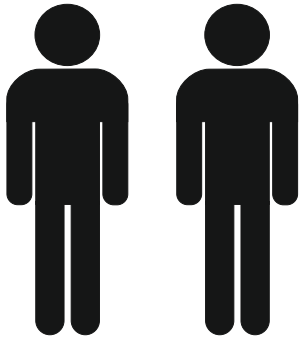
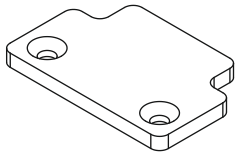

13.01.01.863 x 4

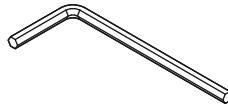

13.07.01.016 x 1



4x16
13.02.01.004 x 8

1 / 1

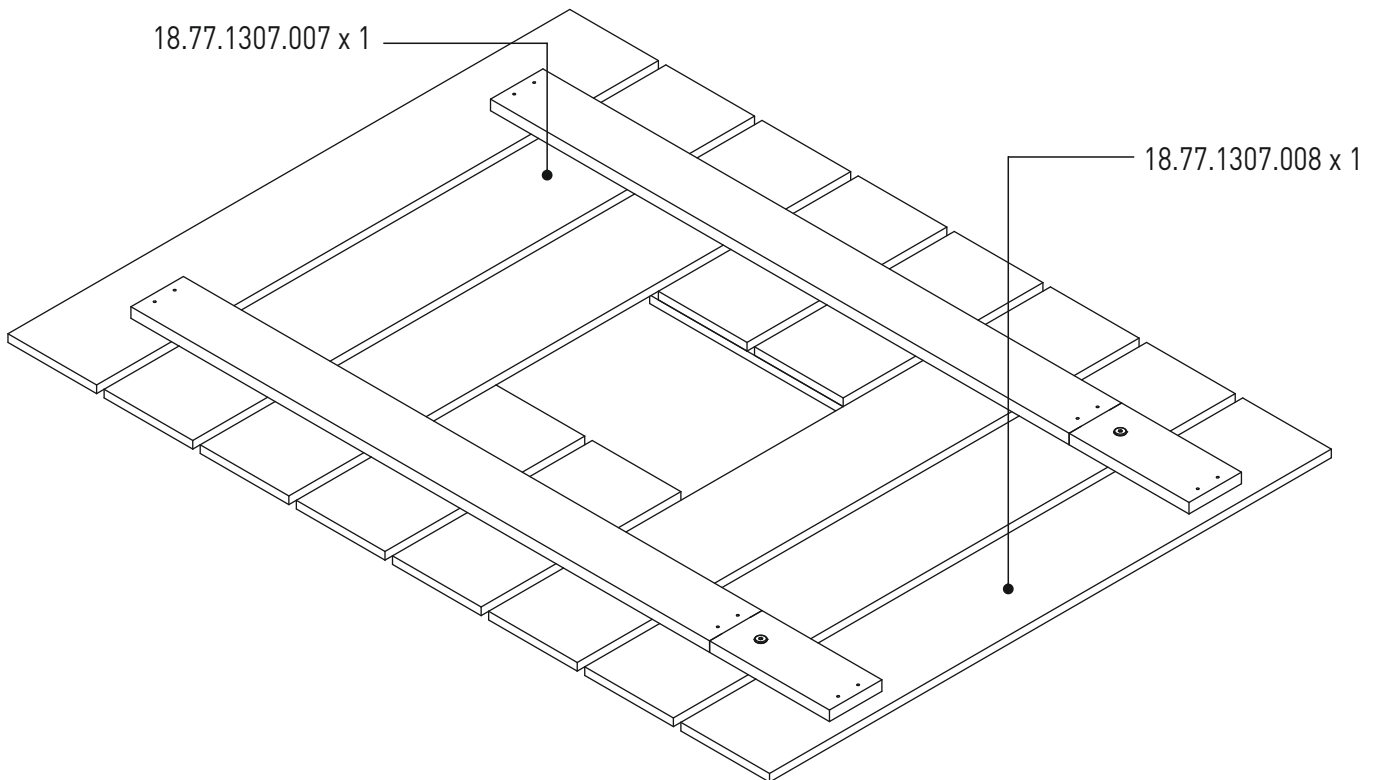

18.77.1307.009

13.01.01.863 x 4

13.02.01.004 x 8
4x16

1

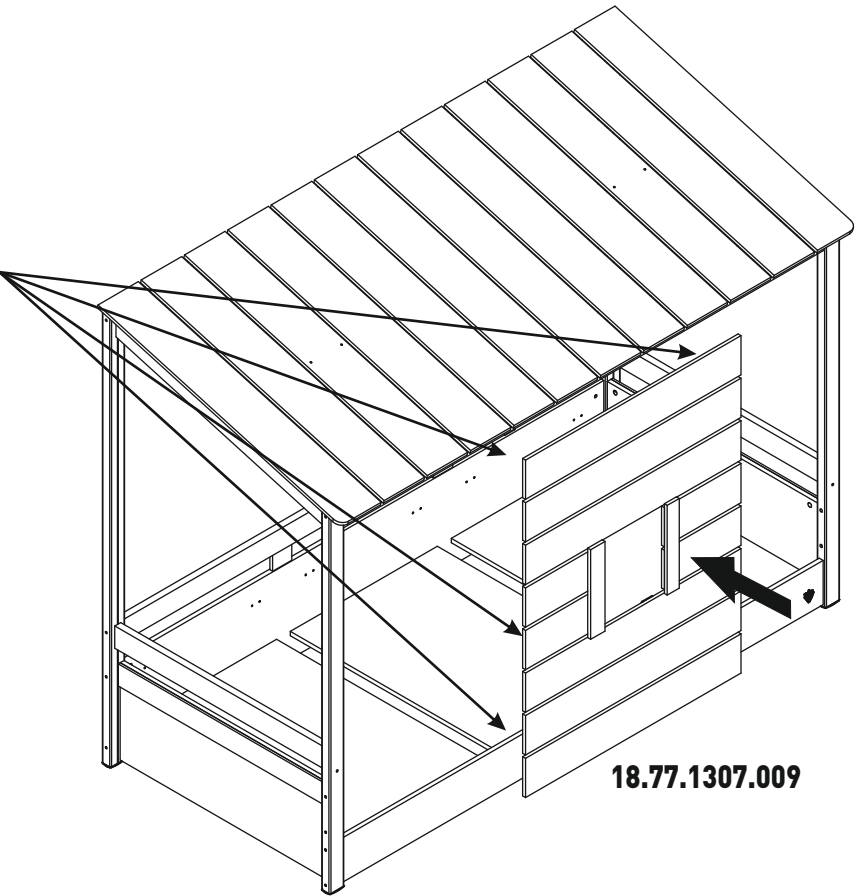
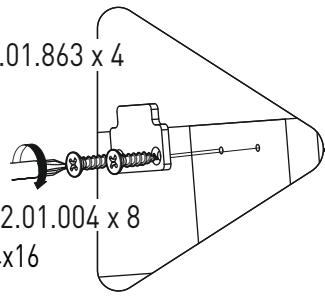

18.77.1307.009

20.77.1304.00

i

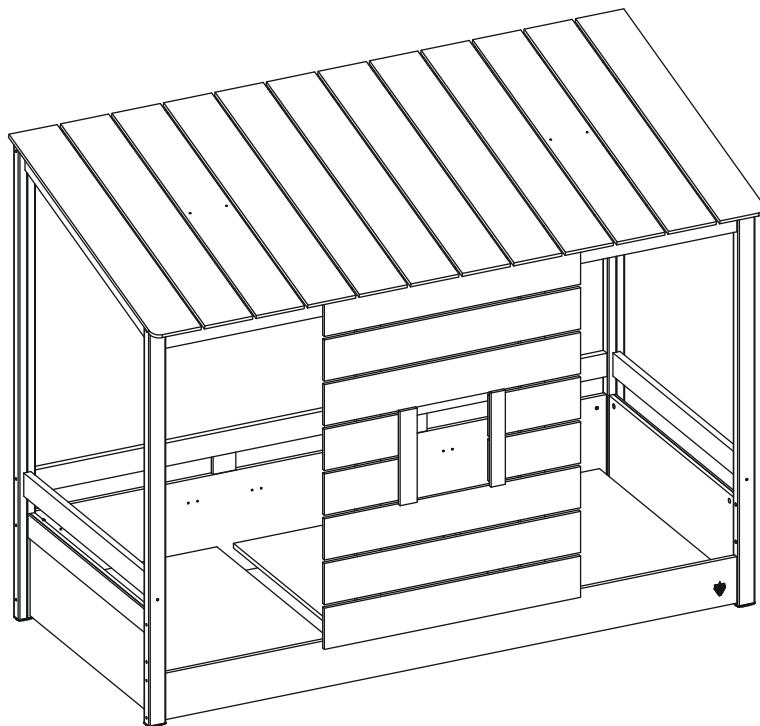

20.77.1304.00

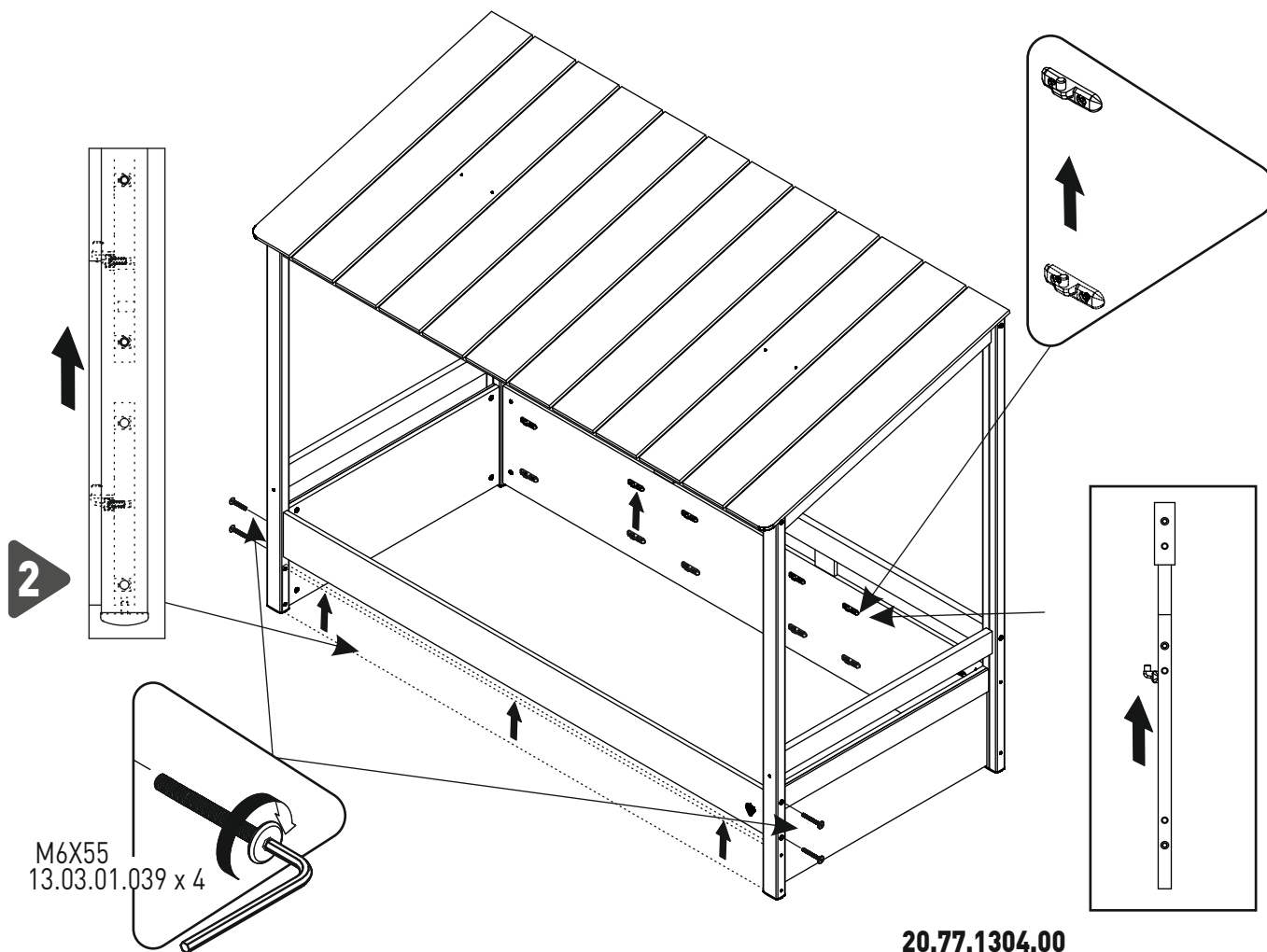
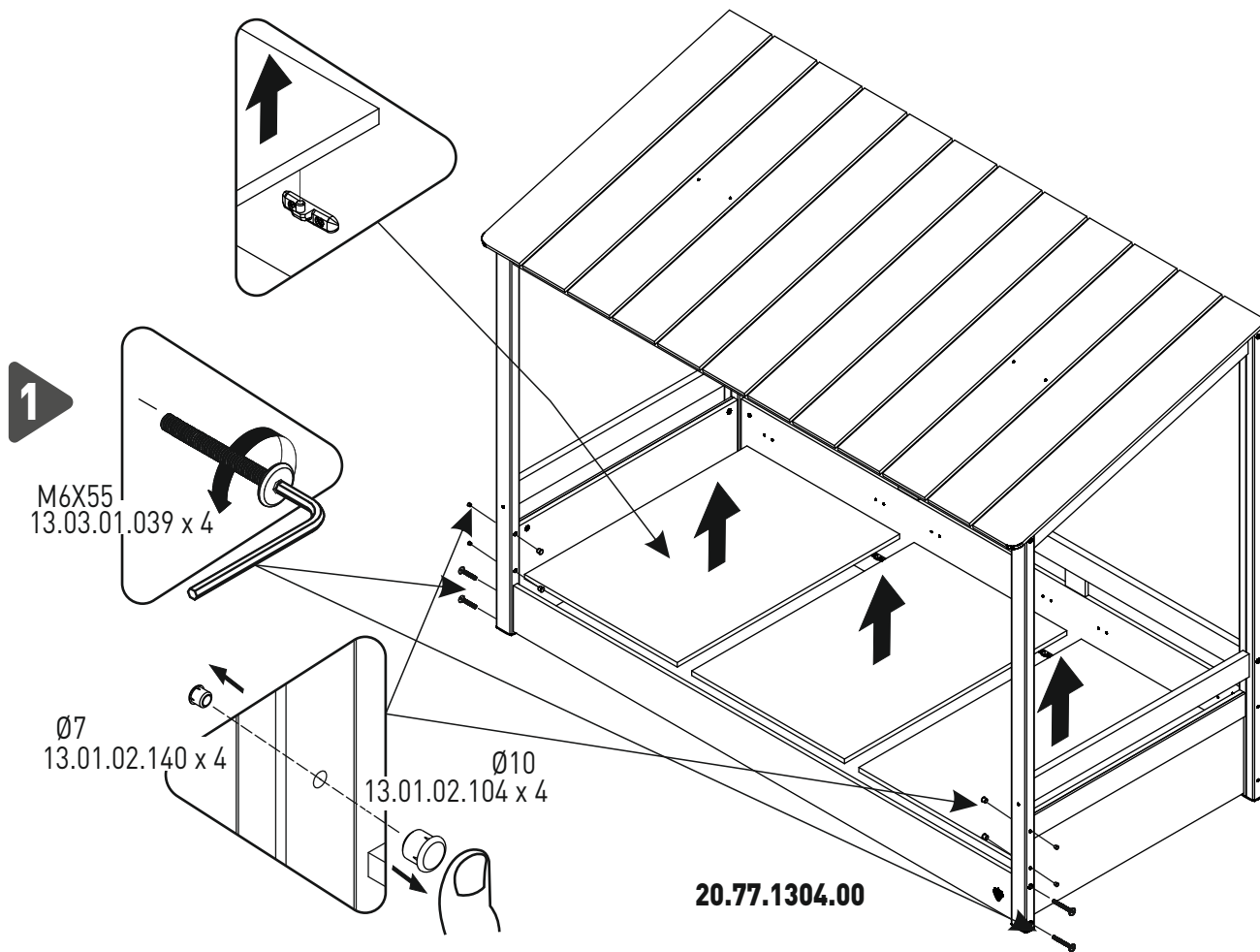

3

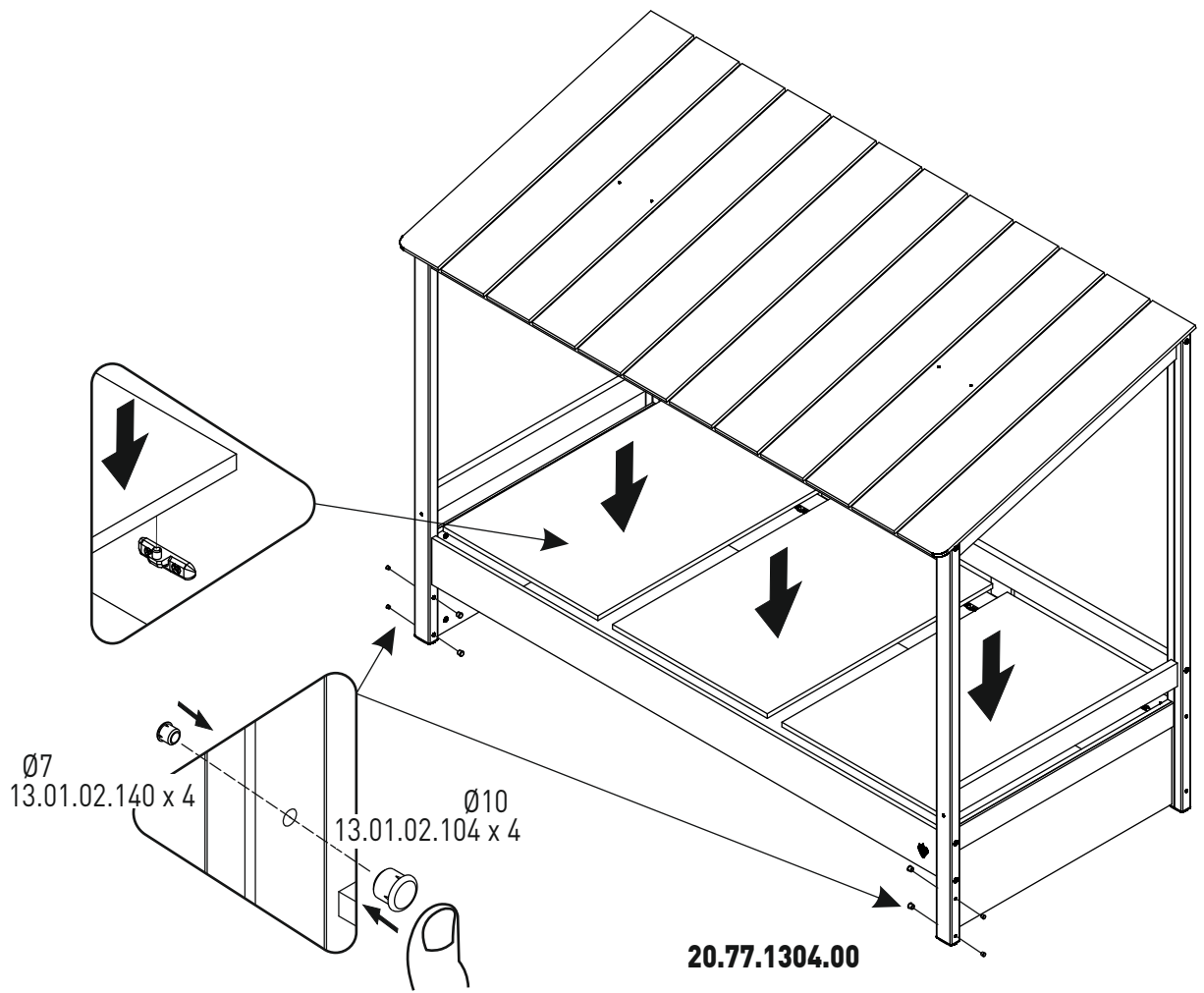

4

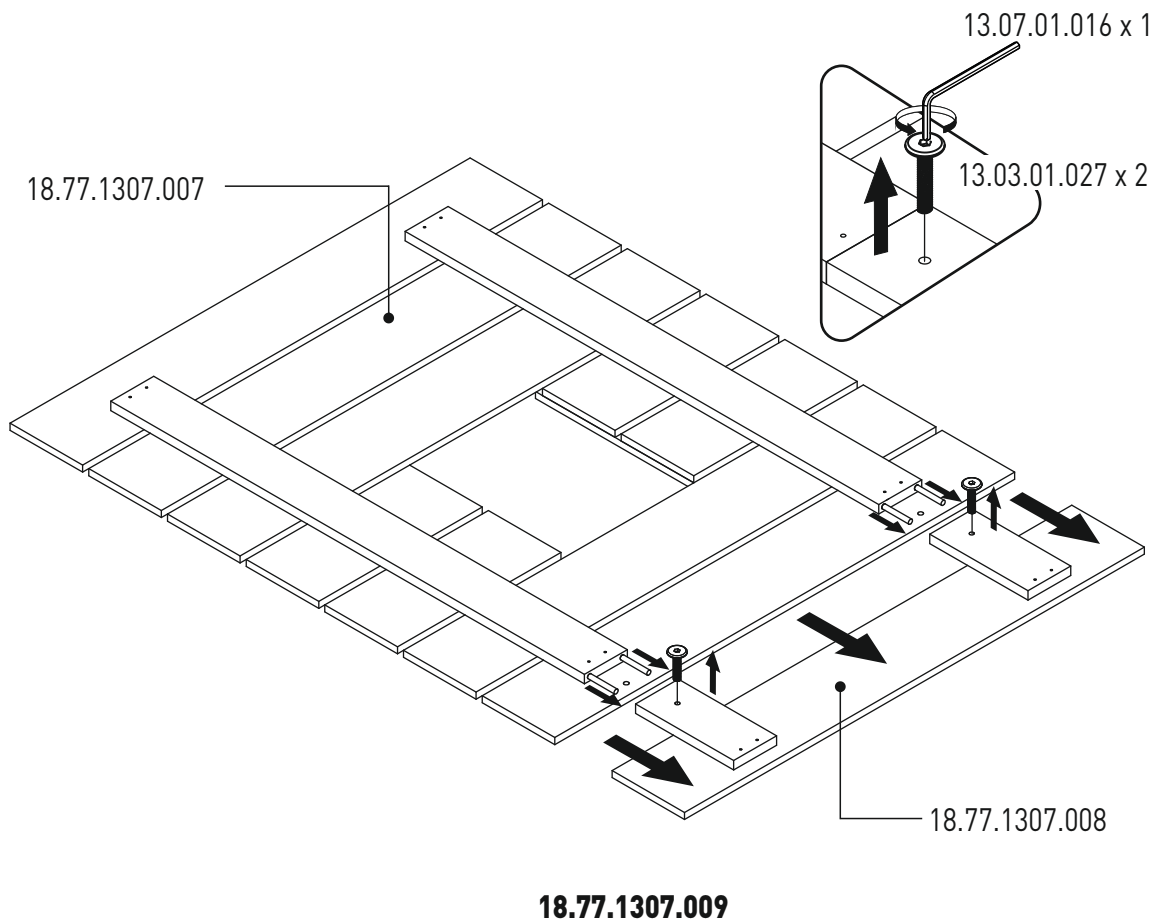

13.01.01.863 x 4

13.02.01.004 x 8
4x16

5

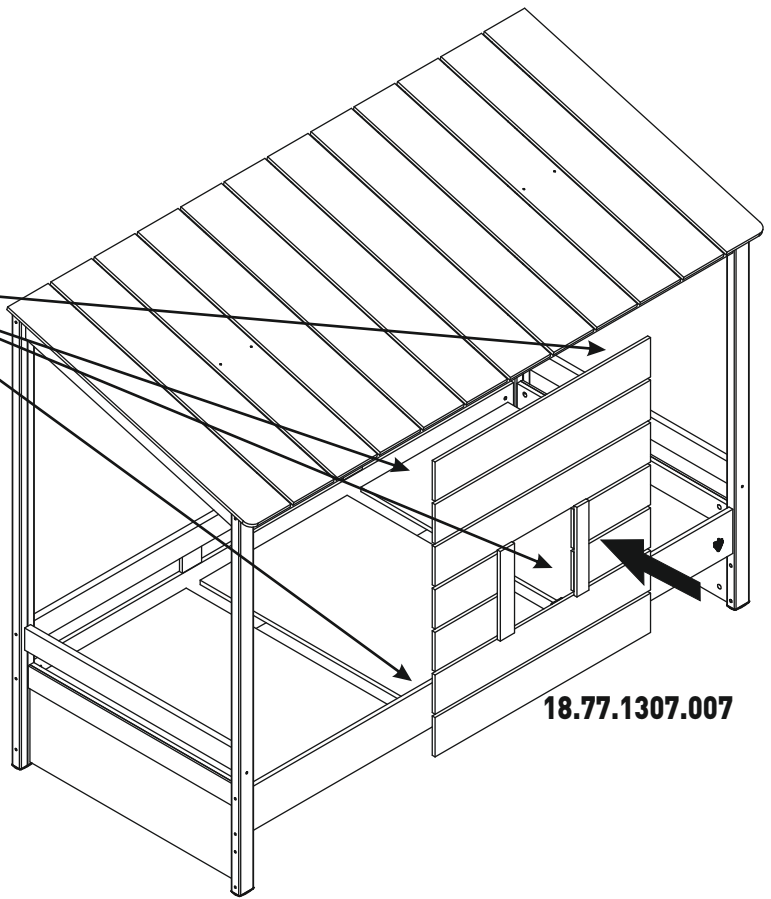

18.77.1307.007

20.77.1304.00

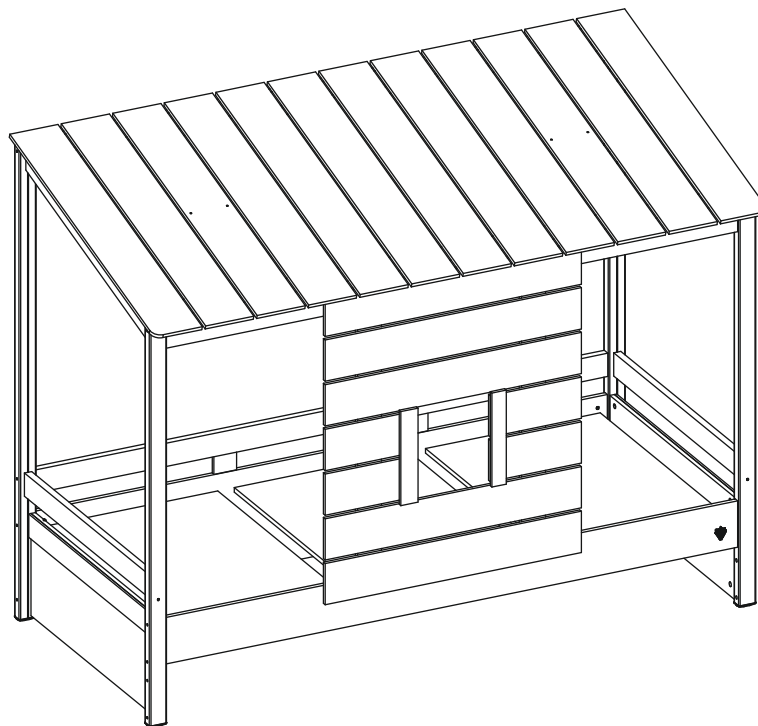

20.77.1304.00

i

